

Article number: 20291130100L1SCR

Description: E+G Linear actuators - GN 291.1-30-100-L1-SCR

Measures

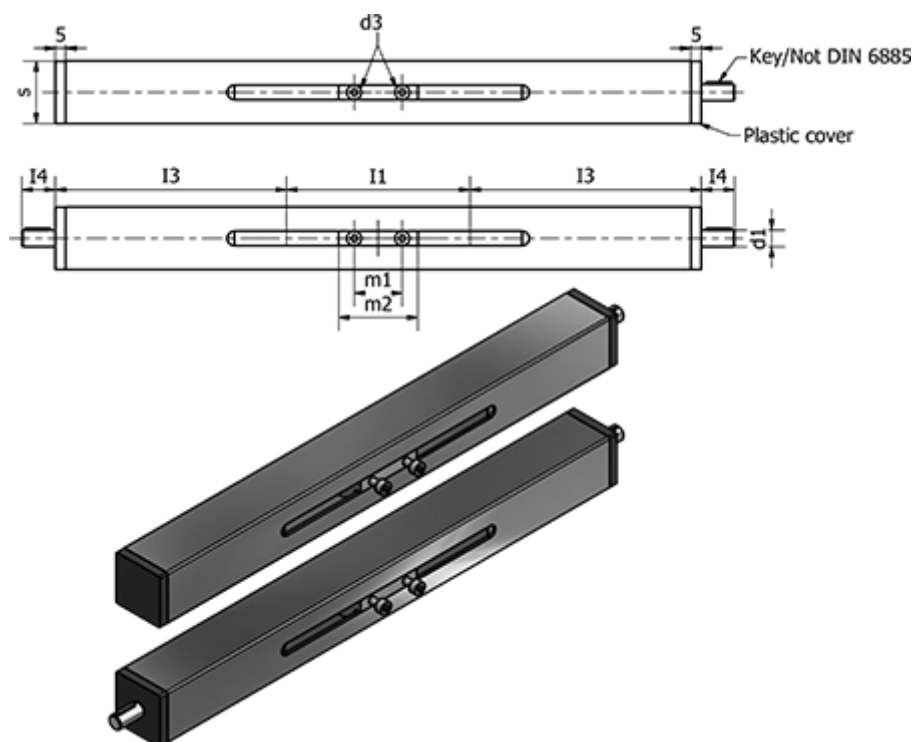

d1 f7 = 8
 d2 = M4
 I1 = 100
 I2 = I2+210
 I3 = 105
 I4 = 16
 m1 = 23
 m2 = 38

Max. travel = 1250
 s = 30
 Shaft key DIN 6885 = A2x2x12
 Shaft thread = TR14x4